



TREKHAKEN • ATTELAGES • ANHÄNGERVORRICHTUNGEN • TOWBARS • ENHANCES • ANHÆNGERTRÆK

Montagehandleiding | instructions de montage | Einbauanleitung | Mounting instruction
Instrucciones de montaje | monteringsvejledning



Maxus eDeliver 5

09/'23-

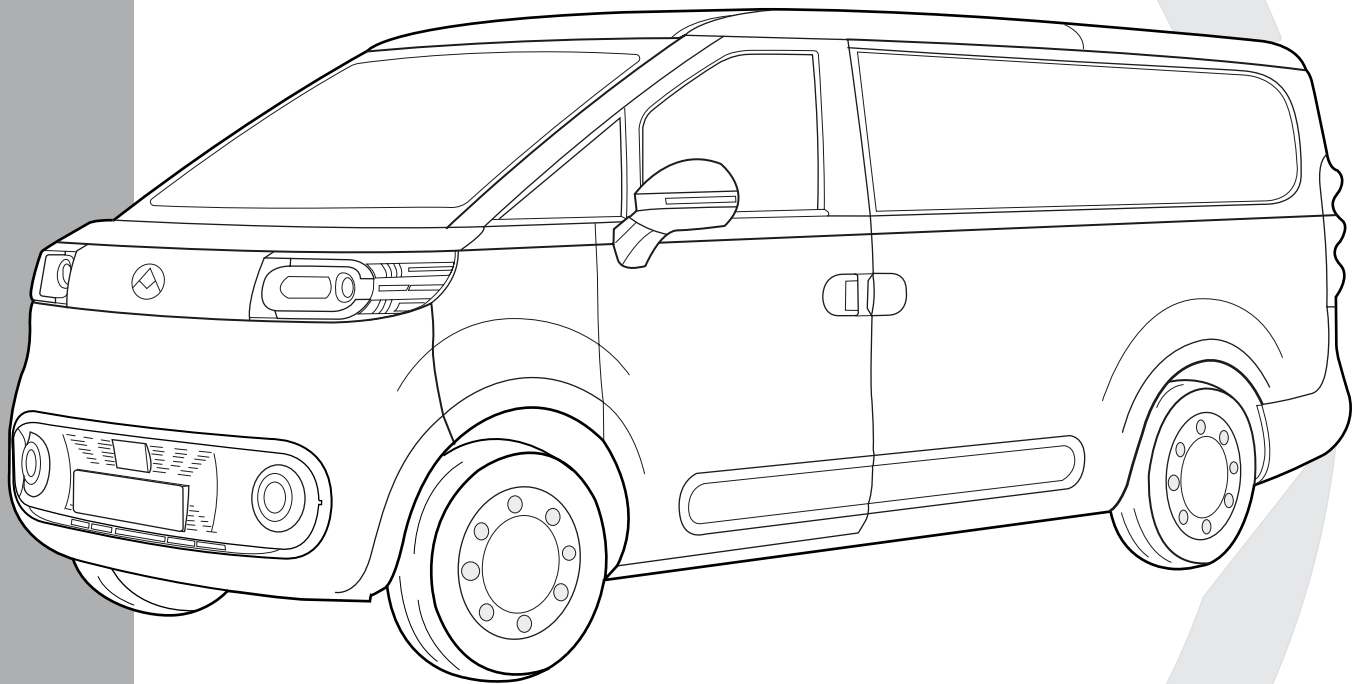

SCAN FOR THE
LATEST VERSION



Gdw nv, Hoogmolenwegel 23 | B | 8790 Waregem | T +32 (0)56 60 42 12 | F +32 (0)56 60 01 93 | gdw@gdwtowbars.com | www.gdwtowbars.com

REVISIENUMMER 000 | N° REVISION 000 | 11•03•2025

2862

NL Belangrijke raadgevingen

Montage

- Voor de montage moet de trekhaak eerst op het voertuig gepresenteerd worden.

De belasting van een aanhangwagen en van een accessoire dat op de koppelingskogel wordt voorzien, zijn anders van aard. Voor beiden kunnen verschillende limieten van toepassing zijn. Hiervoor verwijzen we naar het instructieboekje van de wagen of naar uw concessiehouder.

FR Recommandations importantes

Montage

- Présenter l'attelage sous le véhicule avant d'effectuer le montage.

La charge d'une remorque ou d'un accessoire monté sur la boule d'attelage, sont de nature différentes. Des limites différentes peuvent s'appliquer à l'un et à l'autre. Nous vous recommandons de vous référer à votre livret d'instructions ou de vous renseigner chez votre concessionnaire.

EN General instructions

Fitting

- Present the towbar under the car first to check if all points are right.

The load of a trailer and of an accessory fitted on the towing ball are of a different nature. Different limits may apply to both. For this matter, we refer to the instruction manual of the vehicle or we advise you to contact your concessionaire.

DE Allgemeine Hinweise

Montage

- Halten Sie die Anhängerkupplung zunächst unter das Fahrzeug und prüfen Sie, ob alle Punkte übereinstimmen.

Die Last eines Anhängers und die Last eines an der Zugkugel montierten Zubehörs unterscheiden sich grundsätzlich. Für beide können unterschiedliche Grenzwerte gelten. Wir verweisen diesbezüglich auf die Betriebsanleitung des Fahrzeugs oder empfehlen Ihnen, sich an Ihren Vertragshändler zu wenden.

ES Instrucciones generales

Montaje

- Presentar el enganche debajo del vehículo antes de realizar el montaje.

La carga de un remolque y un accesorio montado en una bola de remolque son de una naturaleza diferente. Se pueden aplicar diferentes límites a ambos. Para este asunto, nos referimos al manual de instrucciones del vehículo o le recomendamos que contacte a su distribuidor.

DK Generelle instruktioner

Montering

- Præsenter trækstangen under bilen først for at kontrollere, om alle punkter er rigtige.

Belastningen af en trailer og af tilbehør tilkoblet anhængertrækket er forskellige. Der kan være forskellige begrænsninger på begge. I disse tilfælde henviser vi til bilens manual, eller anbefaler dig at kontakte bilforhandleren

IT Consigli importanti

Montaggio

- In primo luogo, presentare la struttura sotto l'automobile per verificare che tutti i punti di attacco coincidano.

La massa rimorchiabile del veicolo potrebbe essere diversa dal valore riportato sul documento del gancio di traino. Per questo motivo, vi invitiamo a consultare sempre la carta di circolazione del veicolo (Pos. O.1) o a rivolgervi al vostro concessionario di fiducia

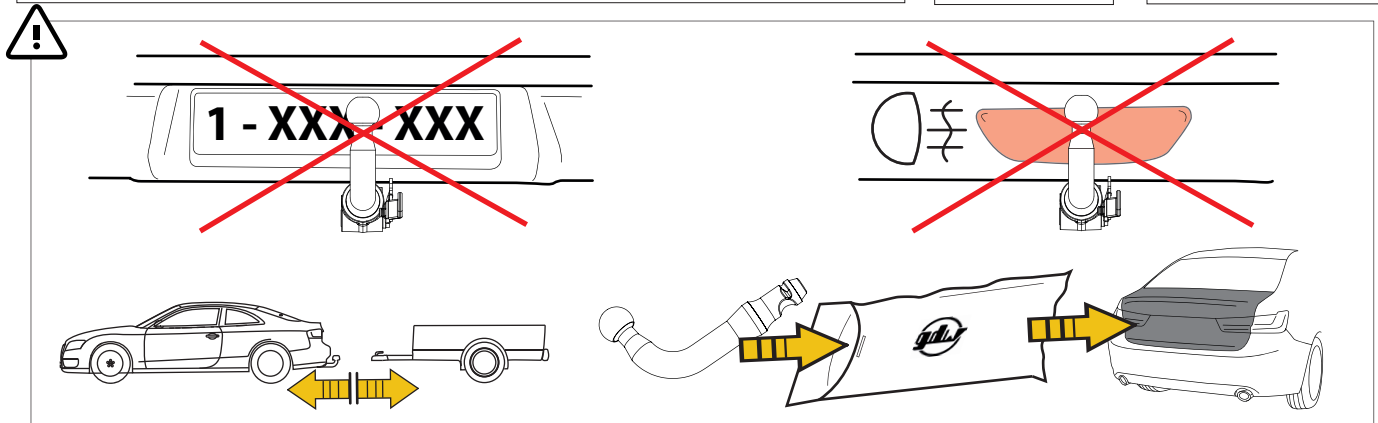
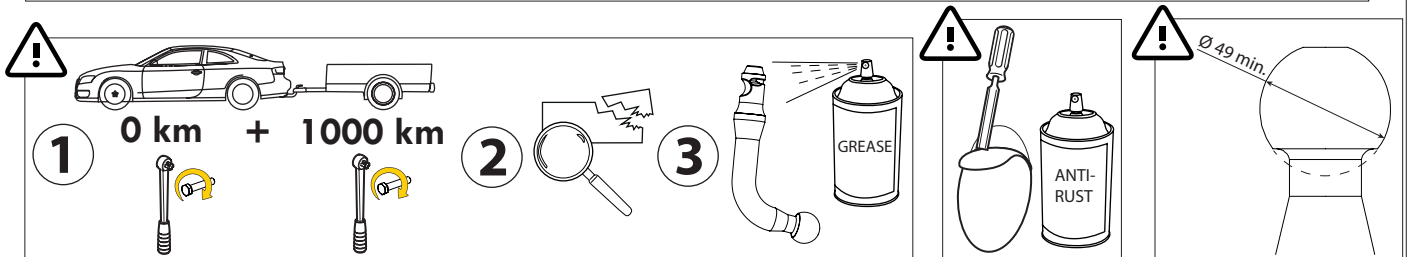
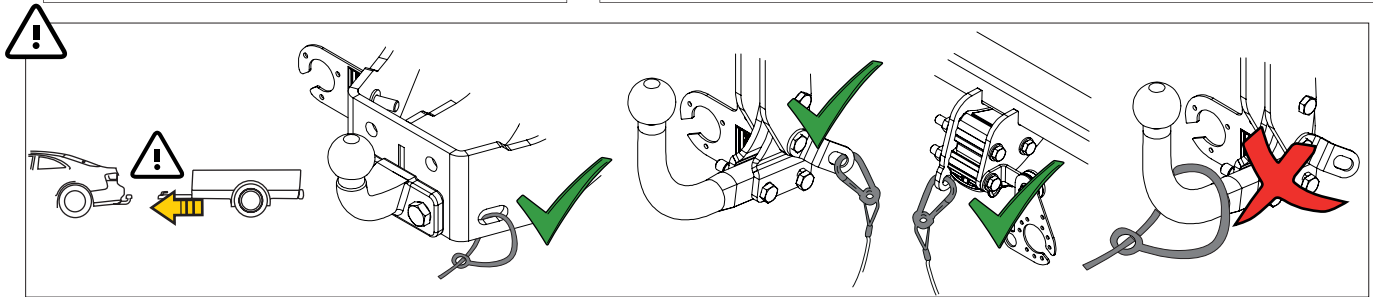
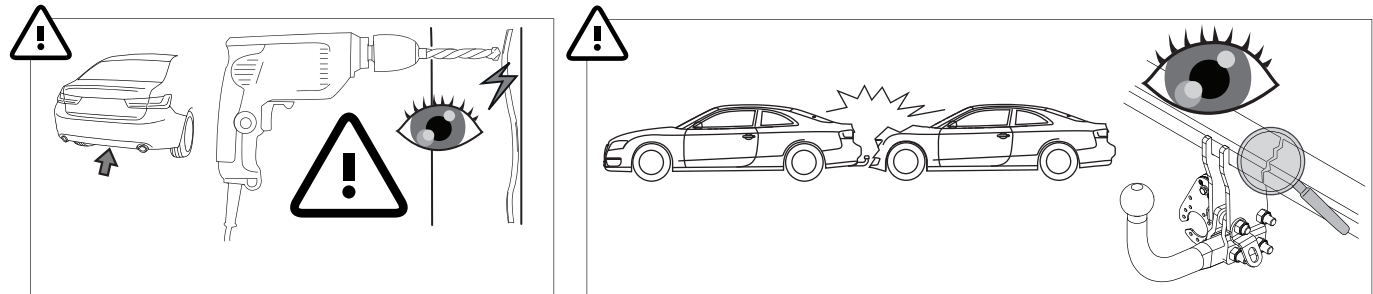
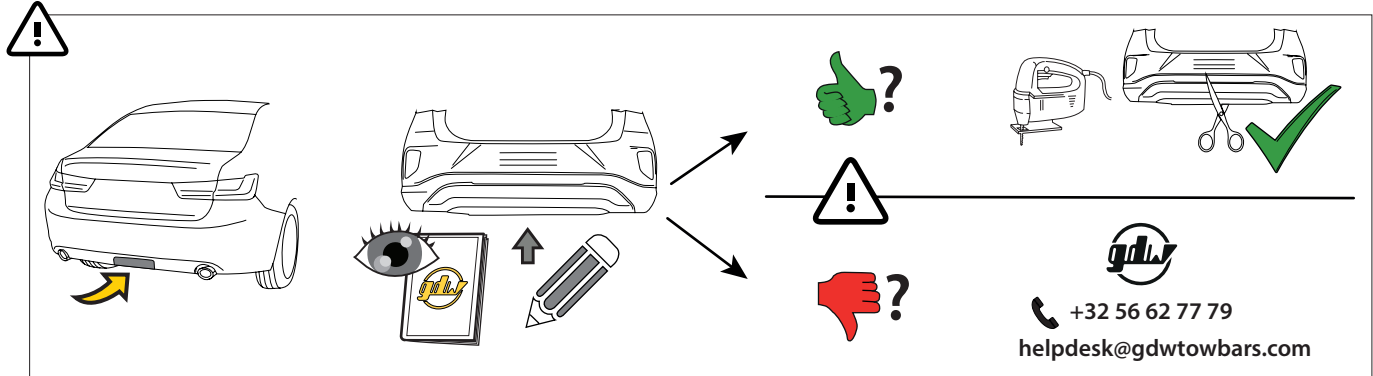
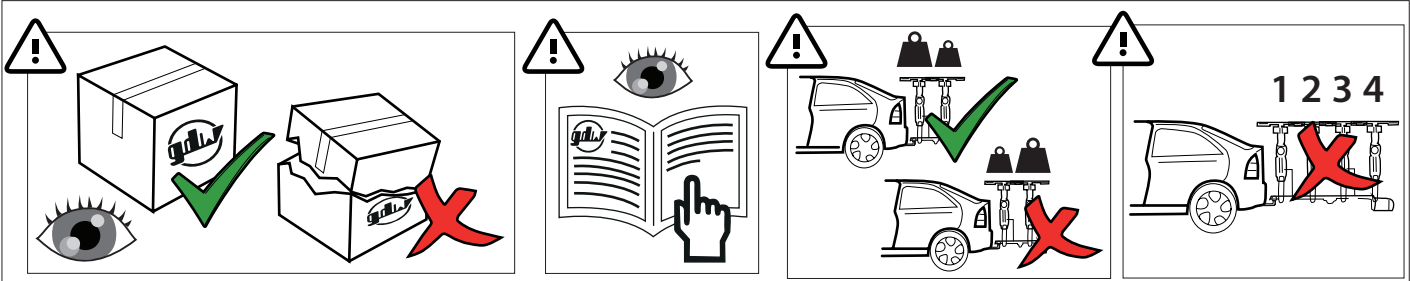

MADE BY 	D 10,33	F	E6
BELGIUM	S 100	EC-N° 55R-02 1859	
REF N° 2862		SERIAL N° XXXX	
DESCRIPTION Maxus eDeliver 09/'23-			

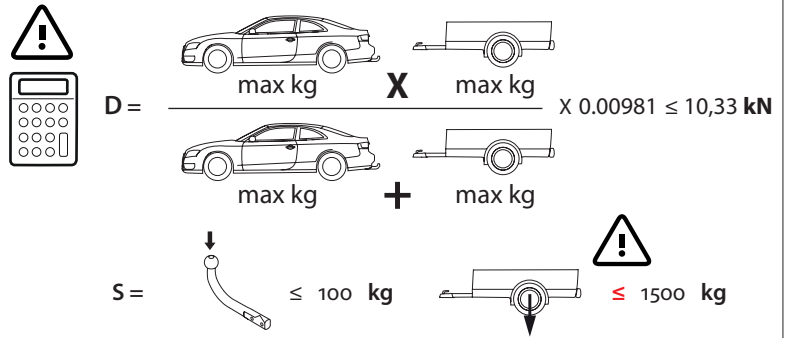

! See the Certificate Of Conformity (COC) of your vehicle or contact your dealer to verify the max. trailer weight of your car!

! See the user manual of the vehicle for correct use of bicycle carriers!

! Reduced functionality for Kick Sensor!

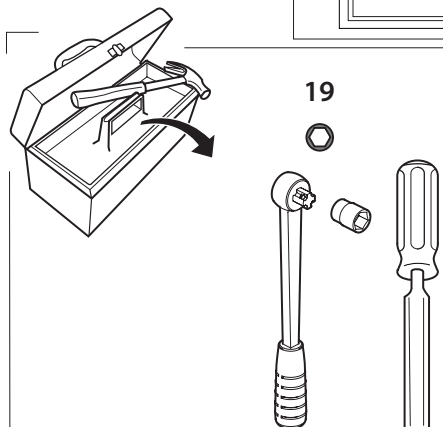
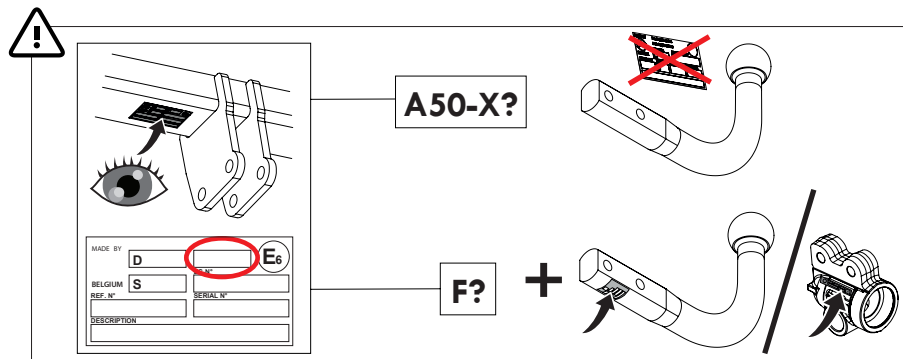
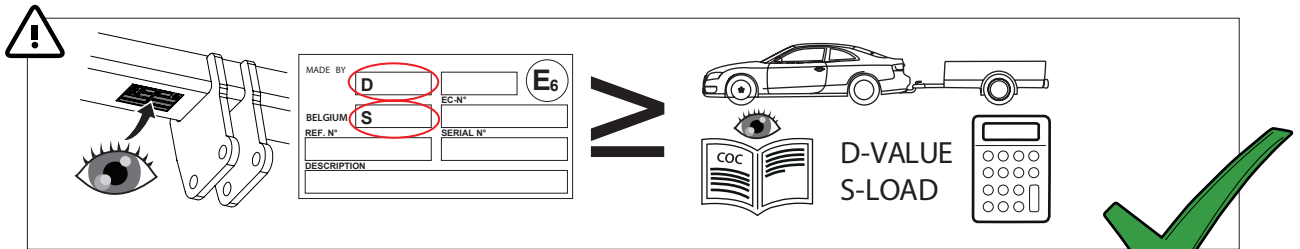
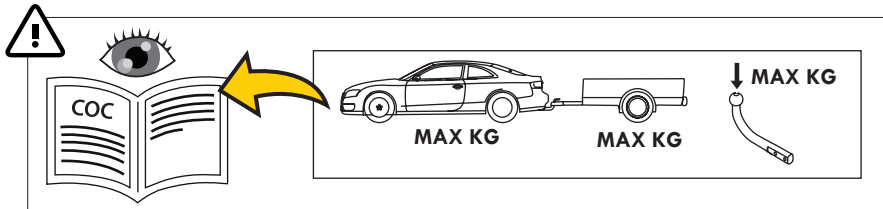

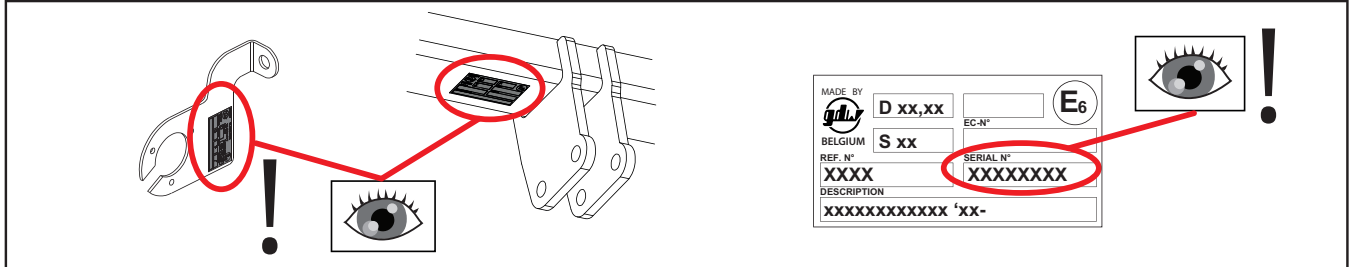





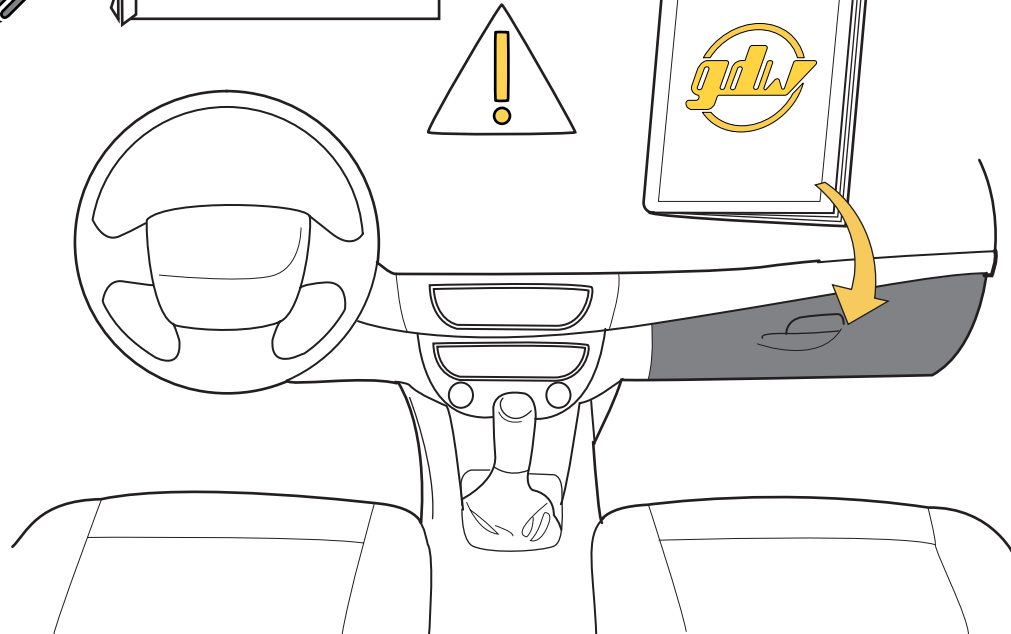

helpdesk@gdwtowbars.com

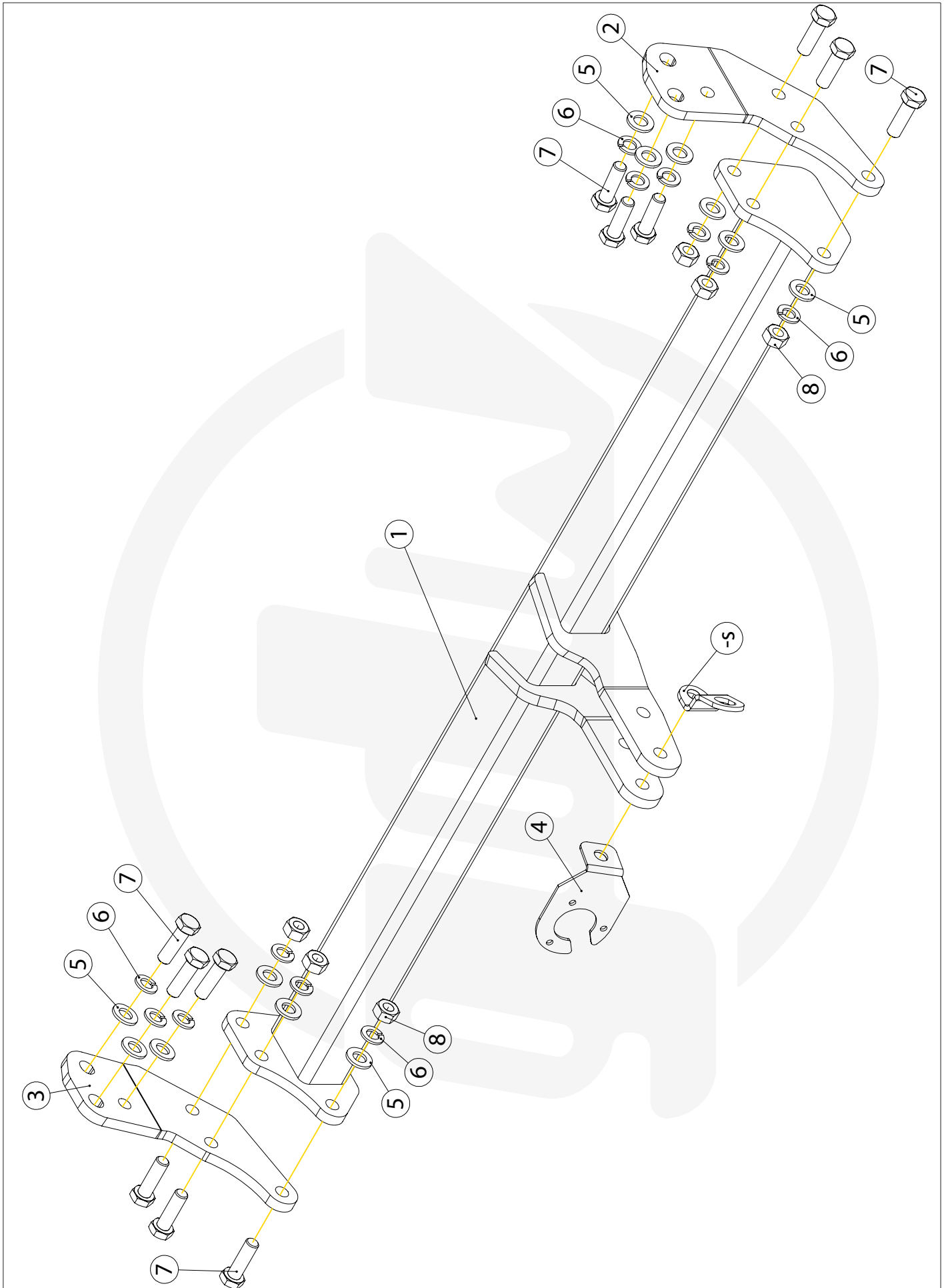

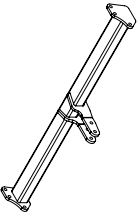
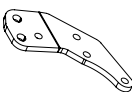
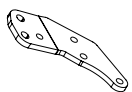
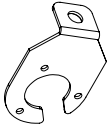
+32 56 62 77 79

Monday	08:00 - 12:00	12:30 - 16:30
Tuesday	08:00 - 12:00	12:30 - 16:30
Wednesday	08:00 - 12:00	12:30 - 16:30
Thursday	08:00 - 12:00	12:30 - 16:30
Friday	08:00 - 12:00	12:30 - 15:30





1		X1	GDW REF. 2862
2		X1	GDW REF. 2
3		X1	GDW REF. 3
4		X1	GDW REF. 4
5		X12	DIN 125A-13X24X2.5
6		X12	GROWER VSK-M12
7		X12	DIN 933-M12X40
8		X6	DIN 934-M12
-5		X1	GDW REF. 900.053

Geleverd met - Livré avec - Delivered with Geliefert mit - Elementos adjuntos-Leveres med		
	X1	944.K004
	X4	DIN931-M12 X 70
	X4	DIN985-M12

1

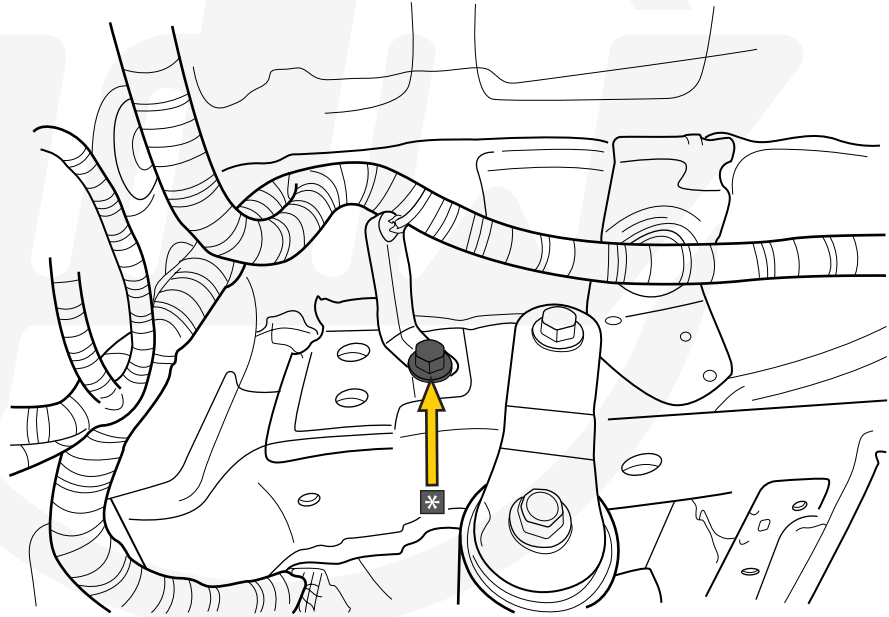
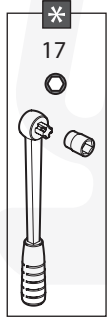
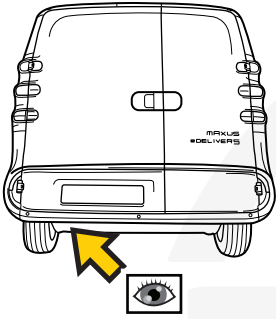

2

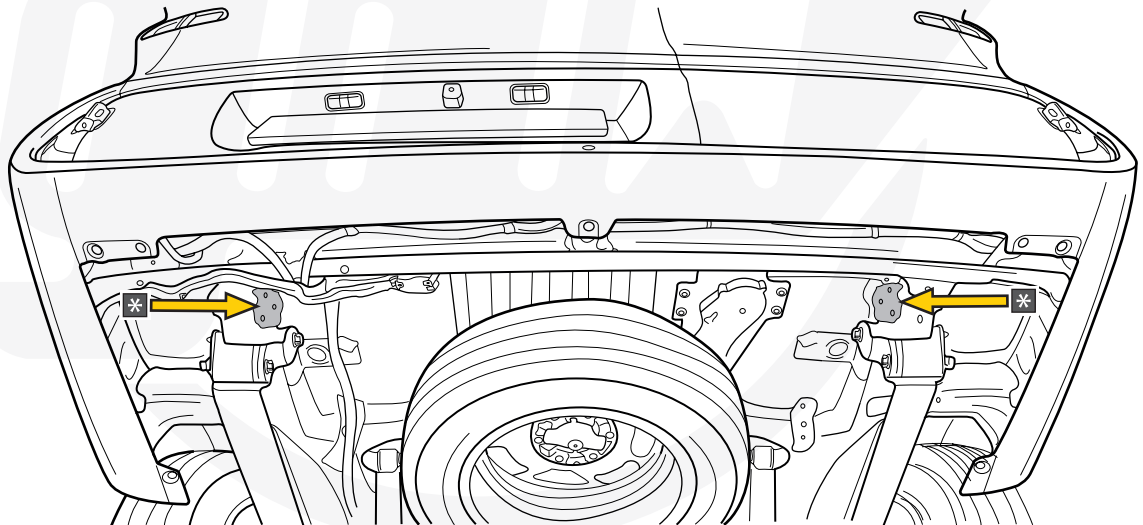
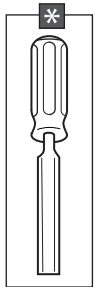
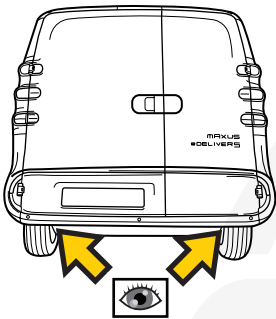

3

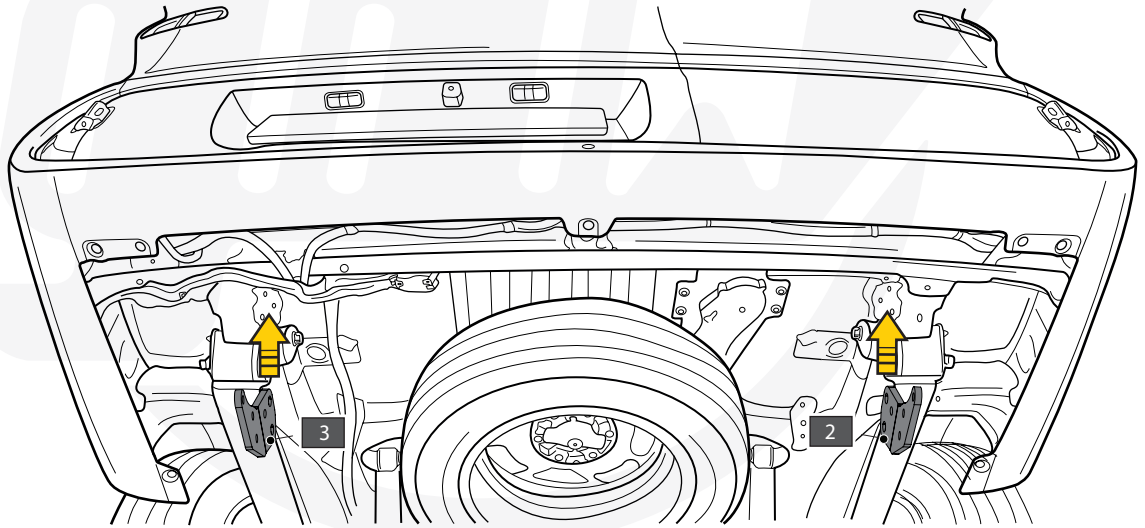
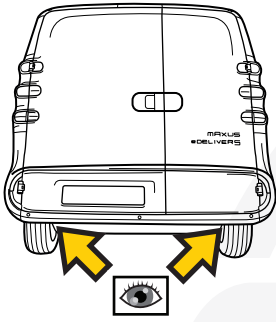

4

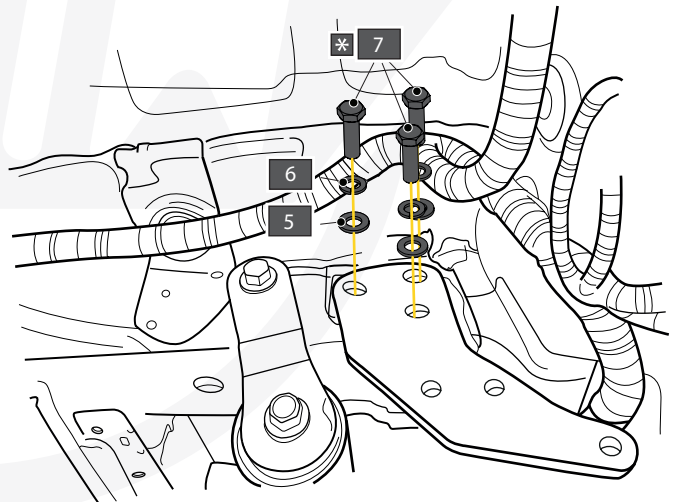
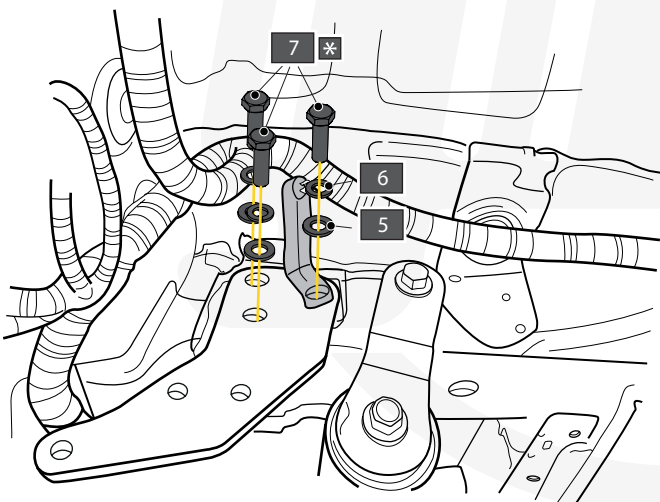
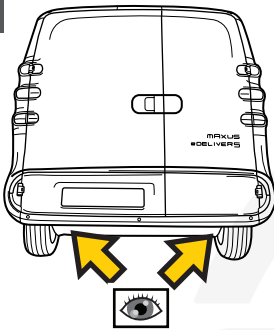

5

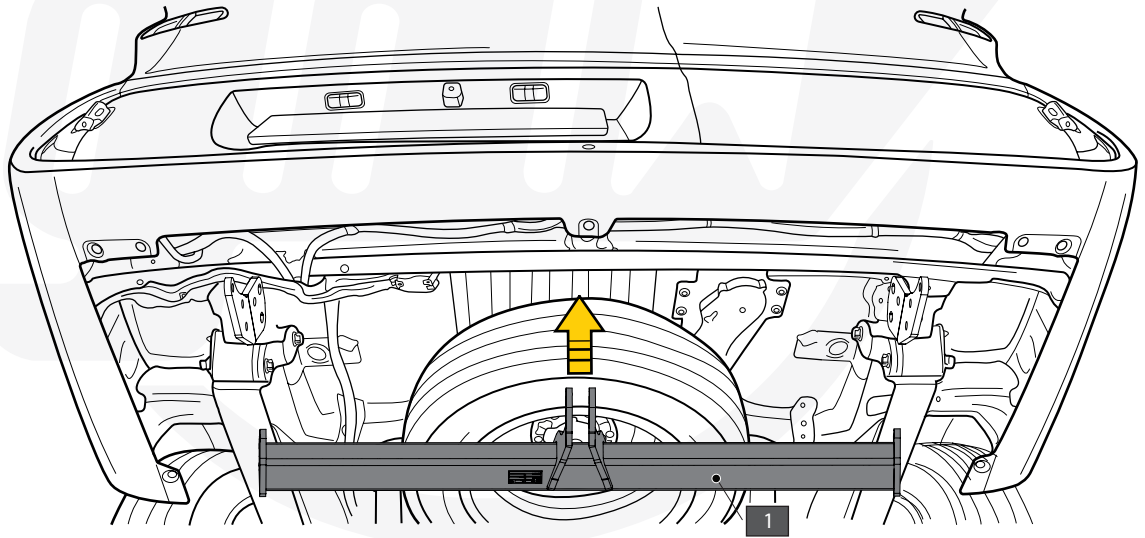
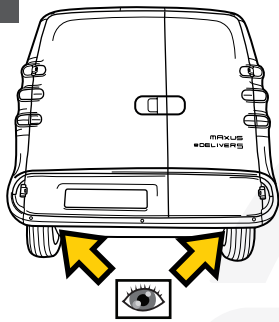

6

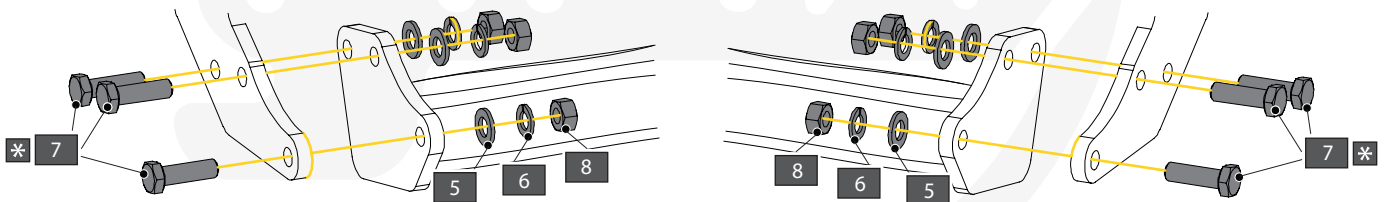
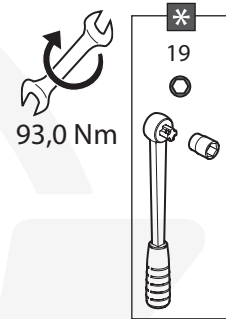
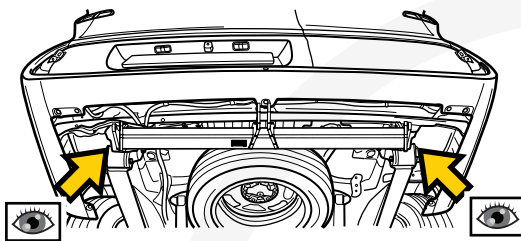

7

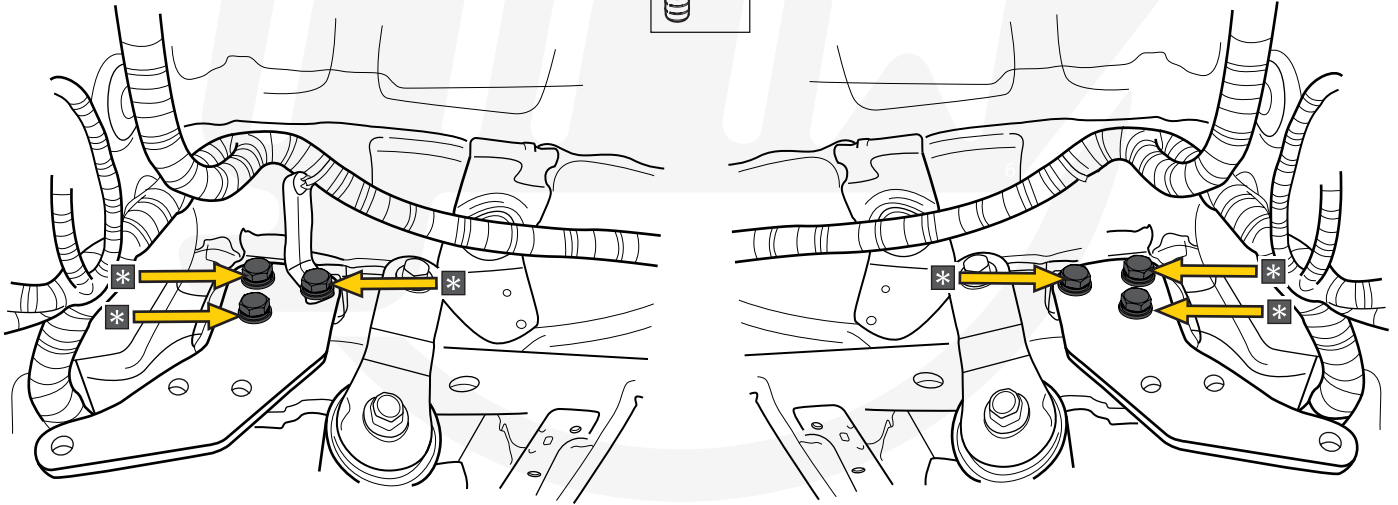
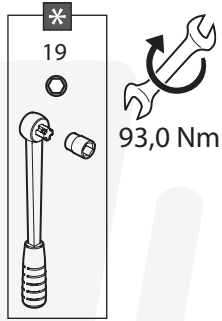
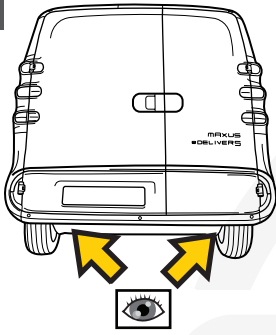

8

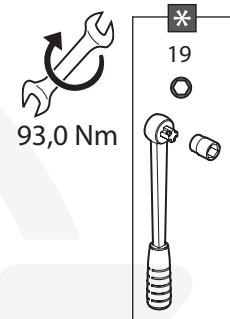
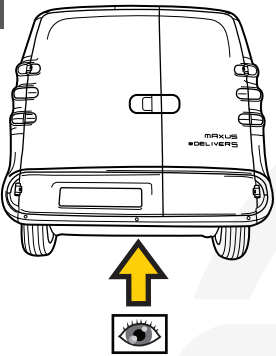

A		X2	944.K007
B		X2	DIN931-M12 X 70
C		X2	DIN985-M12
4		X1	GDW REF.4
-S		X1	GDW REF. 900.053

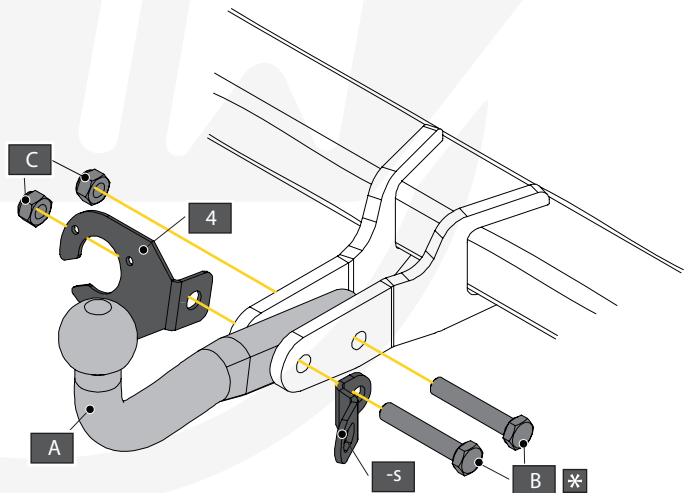

DICHIARAZIONE DI CORRETTO MONTAGGIO

DECLARATION OF CORRECT INSTALLATION

La sottoscritta ditta dichiara di aver montato in maniera corretta il dispositivo di traino di cui sotto, **seguendo le prescrizioni del costruttore del veicolo e del costruttore del dispositivo.**

The undersigned company declares to have correctly mounted the towing device mentioned below, following the prescriptions of the vehicle manufacturer and the construction manufacturer.

COSTRUTTORE	MANUFACTURER	GDW N.V.
RIFERIMENTO	REFERENCE	2862
AUTOVEICOLO	VEHICLE	MAXUS eDELIVER 5 09/'23-
CLASSE E TIPO DI ATTACO	CLASS	F
APPROVAZIONE	HOMOLOGATION	E6*55R02/02*1859
VALORE D	D VALUE	10,33 kN

Timbro e firma dell'installatore Stamp & signature of installer

DATA
DATE

MASSA RIMORCHIABILE	TOWABLE MASS	Vedere carta circolazione del veicolo See registration certificate of vehicle
CARICO VERTICALE MAX. S	MAX. VERTICAL LOAD S	100 kg

Per facilitare il controllo della compatibilità del dispositivo di traino sul veicolo, è opportuno confrontare le masse riportate sulla carta di circolazione del veicolo con le masse di riferimento sotto riportate (**T** ed **C**):
To simplify checking the compatibility of the towing device on the vehicle, it is advisable to compare the masses shown on the vehicle registration certificate with the reference masses shown below (T and C):

T = Massa complessiva del veicolo in kg *Total vehicle mass in kg*
C = Massa rimorchiabile del veicolo in kg *Towable mass of the vehicle in kg*

Massa complessiva del veicolo, desunta dalla carta di circolazione (**F2**) in kg
Total mass of the vehicle, taken from the registration certificate (F2)

deve essere inferiore od uguale a quella di riferimento **T** (= kg)
must be less than or equal to the reference T

Massa rimorchiabile del veicolo, desunta dalla carta di circolazione (**O1**) in kg
Towable mass of the vehicle, taken from the registration certificate (O1)

deve essere inferiore od uguale a quella di riferimento **C** (= kg)
must be less than or equal to the reference C

Se tali condizioni sono verificate il dispositivo **è installabile.** *If these conditions are met, the device can be installed.*

Se tali condizioni non si verificano, si deve procedere al seguente calcolo:
If these conditions are not met, the following calculation must be made:

$$D = \frac{T \times C}{T + C} \times 0,00981 = \dots\dots\dots \text{ kN}$$

Se **D** risulta inferiore a **10,33 kN** (valore riportato sulla targhetta e sul presente documento) il dispositivo **può essere installato.**
If D is less than 10,33 kN (value shown on the plate and on this document) the device can be installed.

NOTA ESPLICATIVA
EXPLANATORY NOTE

